





LISTA DE PARTES:

Accesorios Anclaje

-  A-01 Ancla x 3
-  A-02 Base anclaje x 1
-  A-03 Tuerca de ajuste x 6
-  A-04 Tuerca cerrada x 3

PRECAUCIÓN:

1-Desconecte la fuente de energía eléctrica durante la instalación y antes de darle servicio.

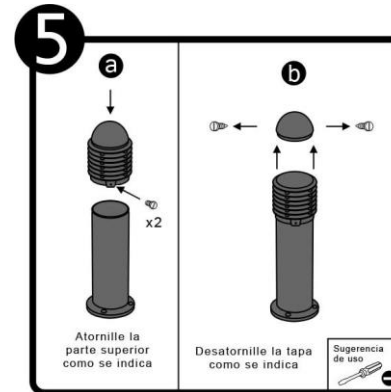
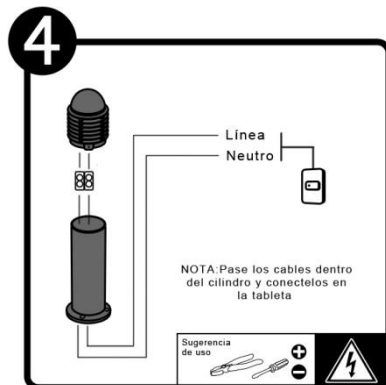
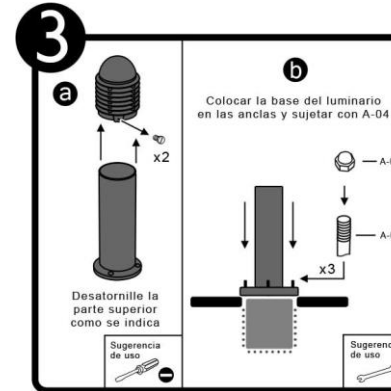
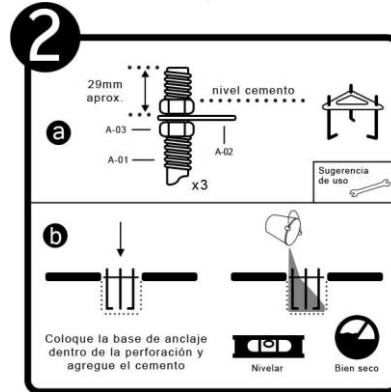
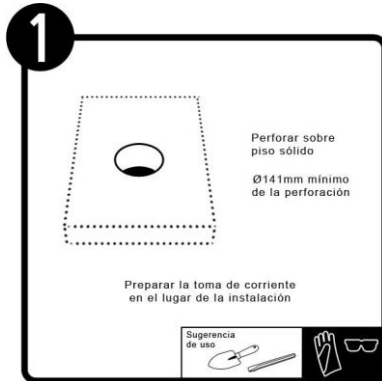

RECOMENDACIÓN: Favor de consultar el instructivo impreso que viene dentro del empaque del producto.