

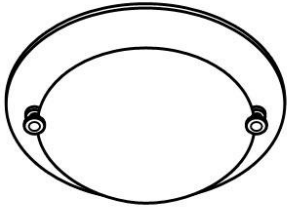



\*Instructivo solo como referencia de instalación

**PRECAUCIÓN:**

1-Desconecte la fuente de energía eléctrica durante la instalación y antes de darle servicio.

**LISTA DE PARTES:**
**Accesorios Anclaje**

-  A-01 Pija x 3
-  A-02 Taquete x 3
-  A-03 Conector rápido x 3

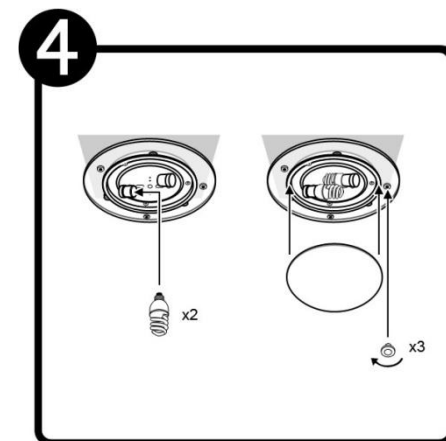
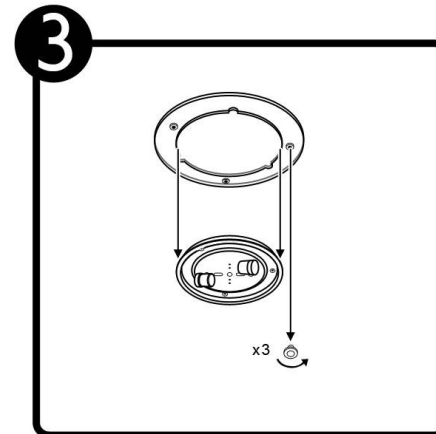
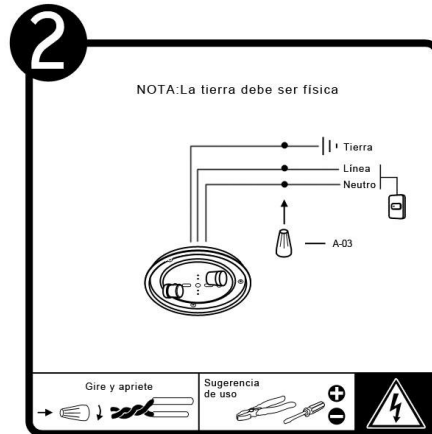
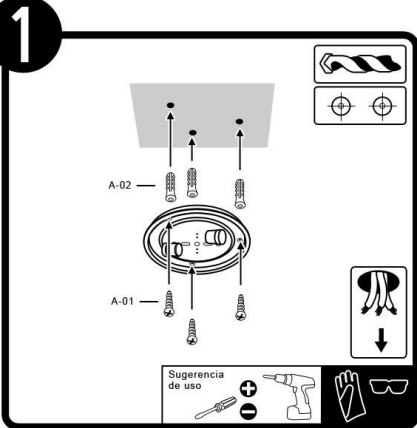
**RECOMENDACIÓN:** Favor de consultar el instructivo impreso que viene dentro del empaque del producto.