

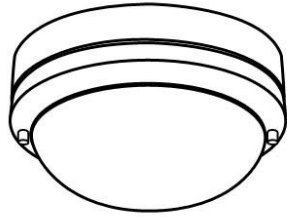

\*Instructivo solo como referencia de instalación

**LISTA DE PARTES:**
**Accesorios Anclaje**
 A-01 Pija x 3

 A-02 Taquete x 3

**PRECAUCIÓN:**

1-Desconecte la fuente de energía eléctrica durante la instalación y antes de darle servicio.

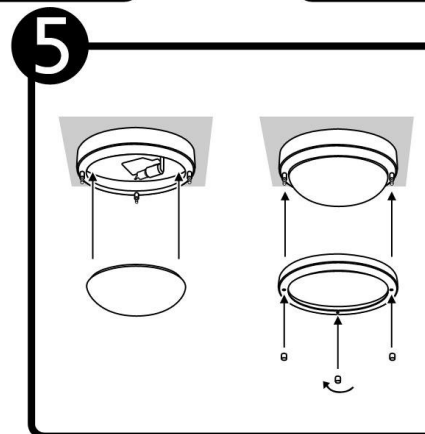
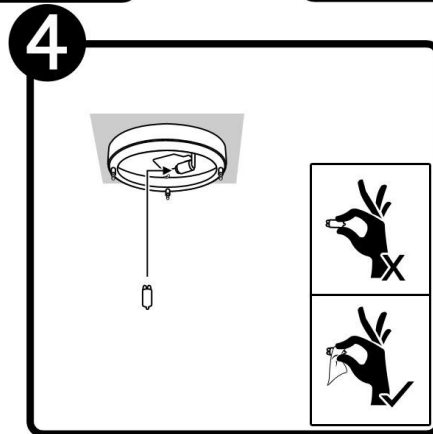
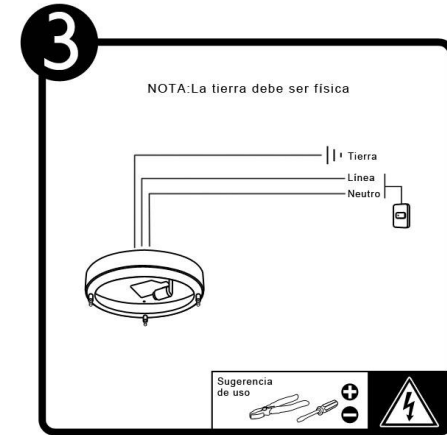
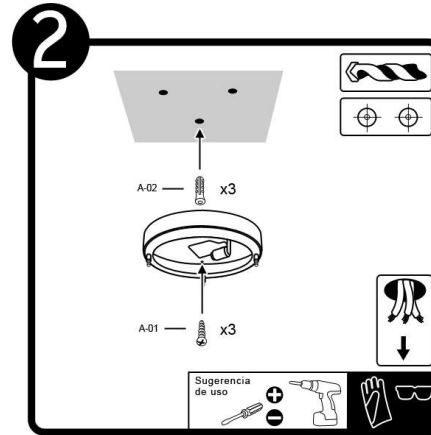
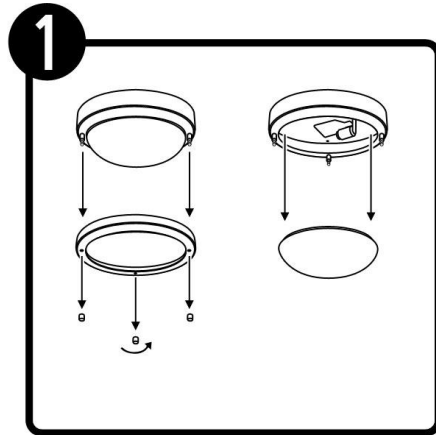
**RECOMENDACIÓN:** Favor de consultar el instructivo impreso que viene dentro del empaque del producto.